

PANTHELLA 400 TABLE LAMP

The fixture emits a glare-free, soft and comfortable illumination. The opal acrylic shade leaves a diffused comfortable light atmosphere due to the translucent shade, the downward reflection from the inner shade and the reflection from the trumpet stem.

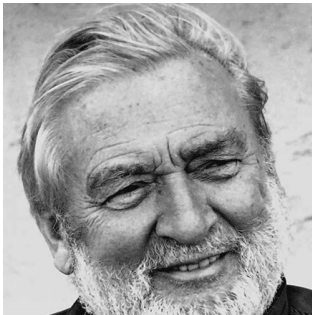

Verner Panton

Verner Panton (1926-1998) is famous for his inspirational and colorful personality. A unique person with a special sense for color, shape, light function and space. Over the course of his career, Panton introduced a series of modern lamps with personalities unlike any of his Scandinavian contemporaries.

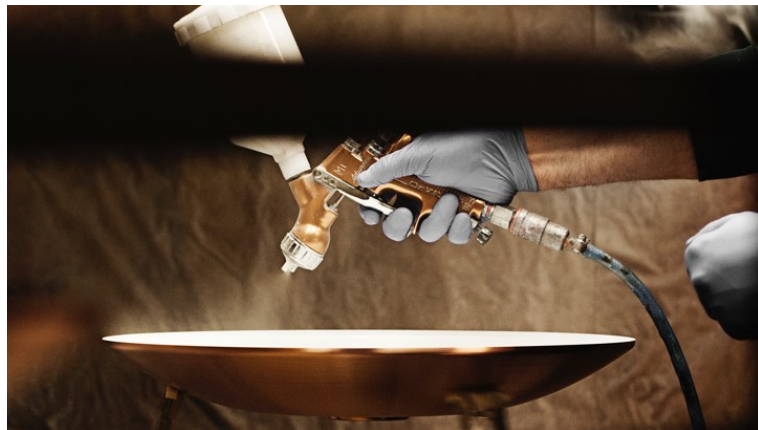

Product info

Environmental Product Specification

This product is compliant with the requirements contained in the European Directives, RoHS Directive 2011/65 and 2015/863. This product is designed so that 100% of the product can be disassembled and reused.

Mounting

Cable type: Plastic cord with plug. Cable length: 2.5m. Light control: On/off switch on cord. Diffuser with bajonet lock.

Finish

White opal acrylic.

Materials

Shade: Injection moulded white opal acrylic. Base: White, injection moulded ABS. Housing: White, injection moulded ABS. Stem: White, steel. Diffuser : Injection moulded opal pmma.

Sizes and weights

Width x Height x Length (mm) | 400 x 550 x 400 Max 2.5 kg

Class

Ingress protection IP20. Electric shock protection II.

Specification notes

The innovation of light sources is ongoing. Consequently we only inform about the max. wattages. On www.louispuolsen.com we update a list of recommendable light sources.

Light source

1x28W E27



Related products



Panthella Floor

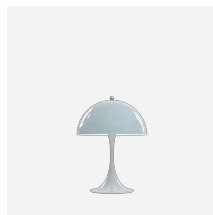

Panthella 250 Table Lamp

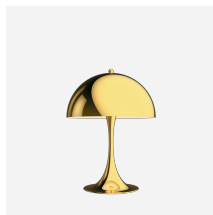

Panthella 320 Table Lamp



Panthella 160 Portable

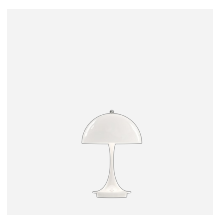

Panthella 160 Portable Metal

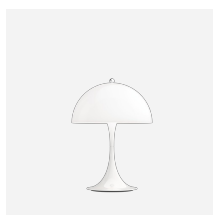

Panthella 250 Portable

Product variants

Light source

1x28W E27

Product description

Modern, all white, portable fixture.
Terse and iconic design
Matching floor version available.

Mounting

Portable fixture plugs into standard wall outlet.

Light description

The fixture emits glare free, comfortable light.
Top hemispherical shade reflects light downwards

Design

Verner Panton

Material

Shade: opal acrylic, 1.5mm (0.06") thick.
Base: injection molded white ABS, 1.5mm (0.06") thick.
Switch: on/off, phenolic, on cord.
Socket: Porcelain, medium base for A-19, frosted envelope lamps.

Weight

2.525

Finish

White opal acrylic

Light distribution diagrams

Cartesian

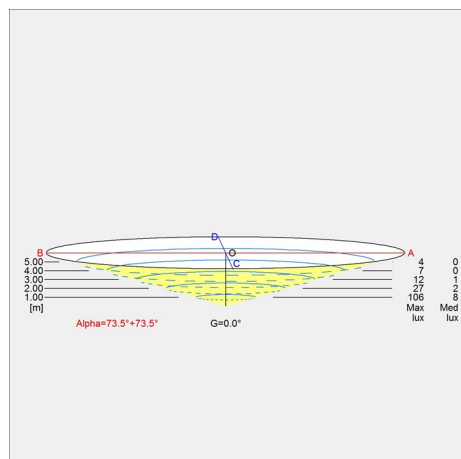

Isolux

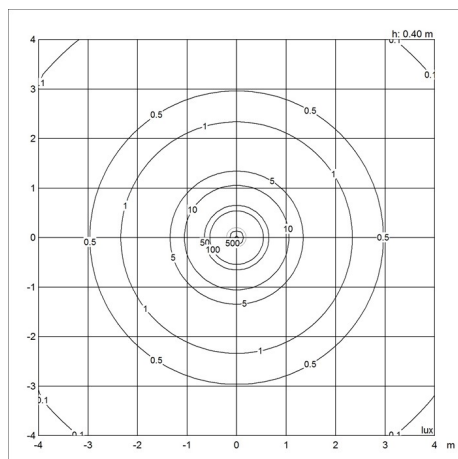

Polar

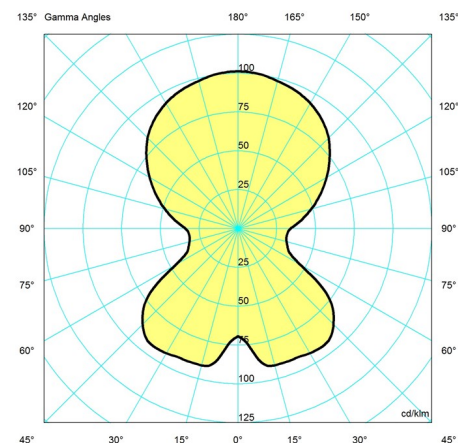

Spare parts & accessories

Product

Panthella Floor/400 chrome nut
 Panthella 400 shade holder clear
 Panthella 400 diffuser
 Panthella 400 bayonet base
 Panthella 400 Opal shade

Variant number

5744610049
 5744610544
 5744167479
 5744167482
 5744167505