

# PANTHELLA 160 PORTABLE

This portable table lamp emits a glare-free, soft, and comfortable light. The metal shade variants reflects the light downwards and provides pleasant illumination created by the inner white painted shade and the reflection from the trumpet-shaped stem. The opal acrylic variants provides gentle illumination and subtle ambience due to the transparency and the reflection of the downward light on the inner side of the shade.

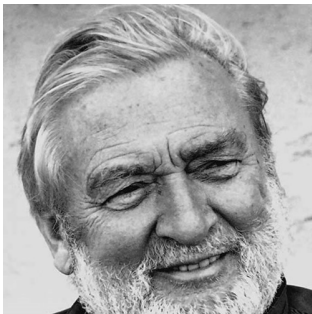
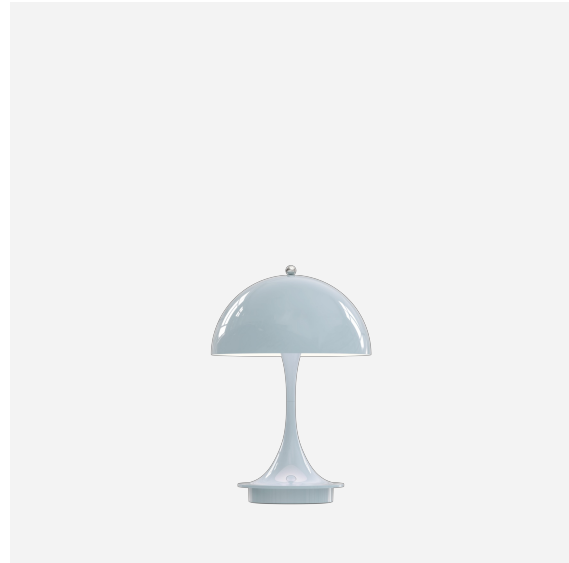

## Verner Panton

Verner Panton (1926-1998) is famous for his inspirational and colorful personality. A unique person with a special sense for color, shape, light function and space. Over the course of his career, Panton introduced a series of modern lamps with personalities unlike any of his Scandinavian contemporaries.



**louis  
poulsen**

## Product info

### Environmental Product Specification

This product is compliant with the requirements contained in the European Directives, RoHS Directive 2011/65 and 2015/863. This product is designed so that 100% of the product can be disassembled and reused.

### Information

Please note that Panthella Portable comes with a USB cable but without adapter and Qi charger. Separate USB adapter is available as accessory. Compatible with standard USB adapters (Min 1.5A) and Qi wireless chargers.

### Mounting

USB-C cable that standard USB-C adapter (min. 1.5A) or Qi wireless charger. White light indicator on base when charging. Light control: Switch on base. Batteries: 3 x AA NIMH, rechargeable and replaceable. Battery lifetime: 5 hours @ 100%. Step dim, short press: 0%/10%/33%/100%. Function to set a fixed light level.

### Finish

Opal acrylic shade in White, Pale Rose or Pale Blue with matching stand. Grey Opal Acrylic shade with high lustre chrome stand. Pale Rose, Pale Blue or Coral, powder coated.

### Materials

Shade: Deep drawn steel or injection moulded opal acrylic. Base and housing: Die cast aluminium

### Sizes and weights

Width x Height x Length (mm) | 160 x 232 x 160 Max 0.4 kg | 160 x 238 x 160 Max 0.4 kg

### Class

Ingress protection IP44. Electric shock protection III.

### Light source

LED 2700K 2.5W

Lumen: 81

### Information

Please note that Panthella Portable comes with a USB cable but without adapter and Qi charger. Separate USB adapter is available as accessory. Compatible with standard USB adapters (Min 1.5A) and Qi wireless chargers.



## Related products



Panthella 400 Table Lamp



Panthella Floor



Panthella 250 Table Lamp

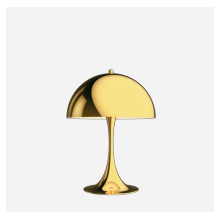

Panthella 320 Table Lamp

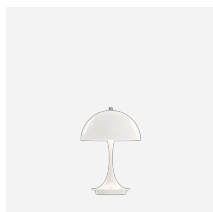

Panthella 160 Portable Metal

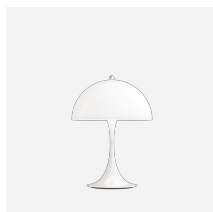

Panthella 250 Portable

## Product variants

| Colour                                     | Light source   | Lumen | Class |
|--|----------------|-------|-------|
| <input checked="" type="radio"/> Black     | LED 2700K 2.5W | 150   | -     |
| <input type="radio"/> Coral                |                | 81    | III   |
| <input type="radio"/> Grey opal acryl      |                |       |       |
| <input type="radio"/> Orange               |                |       |       |
| <input type="radio"/> Pale blue            |                |       |       |
| <input type="radio"/> Pale blue opal acryl |                |       |       |
| <input type="radio"/> Pale rose            |                |       |       |
| <input type="radio"/> Pale rose opal acryl |                |       |       |
| <input type="radio"/> White                |                |       |       |
| <input type="radio"/> White opal acryl     |                |       |       |

# Design

Verner Panton

# Weight

Min: 0.4 kg Max: 0.4 kg

# Finish

Black, Coral, Grey opal acryl, Orange, Pale blue, Pale blue opal acryl, Pale rose, Pale rose opal acryl, White, White opal acryl

# Light distribution diagrams

Cartesian

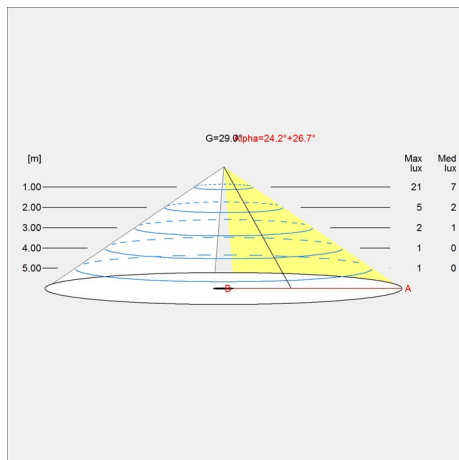

Isolux

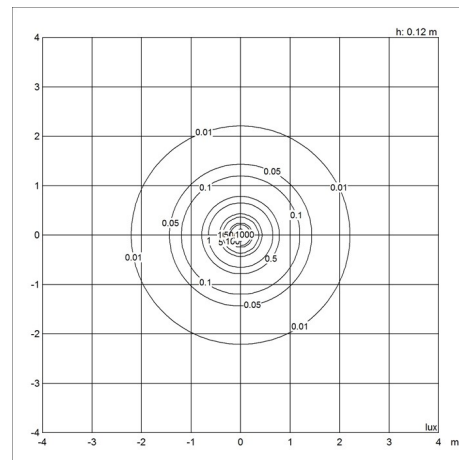

Polar

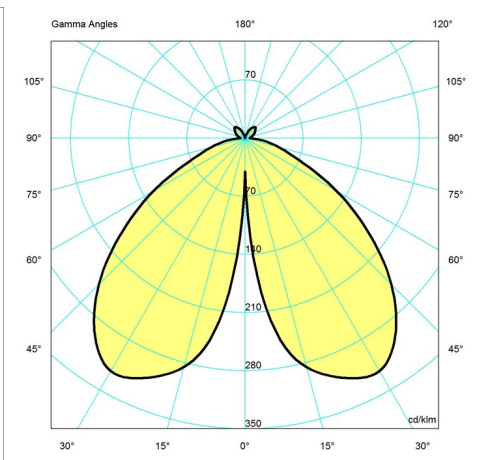

# Spare parts & accessories

## Panthella 160 Portable

| Product                                     | Variant number |
|---|----------------|
| Panthella 160 USB adaptor, white            | 5744166674     |
| Panthella 160 Opal shade                    | 5744166742     |
| Panthella 160 top nut                       | 5744166755     |
| Panthella 160 diffuser w/screws             | 5744168083     |
| Panthella 160 White shade                   | 5744168368     |
| Panthella 160 Black shade                   | 5744168371     |
| Panthella 160 Orange shade                  | 5744168384     |
| Panthella 160 USB cover, black              | 5744168407     |
| Black USB adaptor                           | 5744168410     |
| Panthella 160 V1 Rep. Kit LED w/wire        | 5744166713     |
| Panthella 160 V1 replacement kit print V1   | 5744166726     |
| Panthella 160 V2 Rep. Kit Print             | 5744166739     |
| Panthella 160 Opal Grey shade               | 5744168096     |
| Panthella 160 Pale Blue shade               | 5744612665     |
| Panthella 160 Coral shade                   | 5744612678     |
| Panthella 160 V2 Rubber Pad w/screws        | 5744612762     |
| Panthella 160 Pale Rose shade               | 5744902090     |
| Panthella 160 V2 Rep. Kit LED               | 5744168106     |
| Panthella 160 Portable V2 Batt. Rep. Kit    | 5744620039     |
| Panthella 160 V1 Portable V1 Batt. Rep. Kit | 5744620042     |