

PH ARTICHOKE

The pendant illuminates any space with a 100% glare-free light due to the 72 leaves, which form 12 precisely positioned rows that hold six leaves each. The fixture ensures the light is distributed inwards as well as outwards, thereby emitting a beautiful and comfortable light. Moreover, the high quality of light is maintained in the energy efficient LED variant that creates the same renowned atmosphere around the pendant.

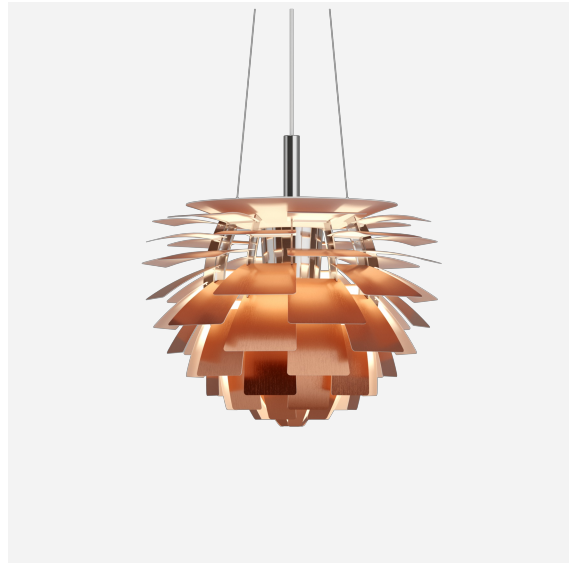

Poul Henningsen

The very influential Danish designer, architect, writer, and cultural critic, Poul Henningsen (1894-1967), has had a huge impact on Danish thinking and design. His legacy is an integrated part of Louis Poulsen's endeavor to shape light.



Atlantic Haus



Overlooking Aarhus

Product info

Mounting

Suspension type: E27: Cable 3 x 0,75mm² & wire. Canopy: Yes. Ø480 LED: Cable 2 x 75mm² and wire. Canopy: Yes. LED canopy contains driver. Ø600/720/840 LED: Cable 2 x 1 mm² and wire. Canopy: Yes. Canopy or external driver box contains driver. Maximum distance between external driver box and fixture: 20m . Cable length: 4m.

Finish

Brass, copper or stainless steel, brushed and coated. Black, powder coated with white, wet painted inner side. White, wet painted.

Materials

Leaves: Laser cut brass, copper or stainless steel. Top shade: Spun steel, white on the bottom. Frame: High lustre chrome plated, laser cut steel. Suspension: High lustre chrome plated, spun aluminium.

Sizes and weights

Width x Height x Length (mm) | 480 x 465 x 480 Max 9.6 kg | 600 x 580 x 600 Max 18.4 kg | 720 x 650 x 720 Max 20.5 kg | 840 x 720 x 840 Max 27.9 kg

Class

Ingress protection IP20. Electric shock protection I w. ground.

Light source

1x100W E27

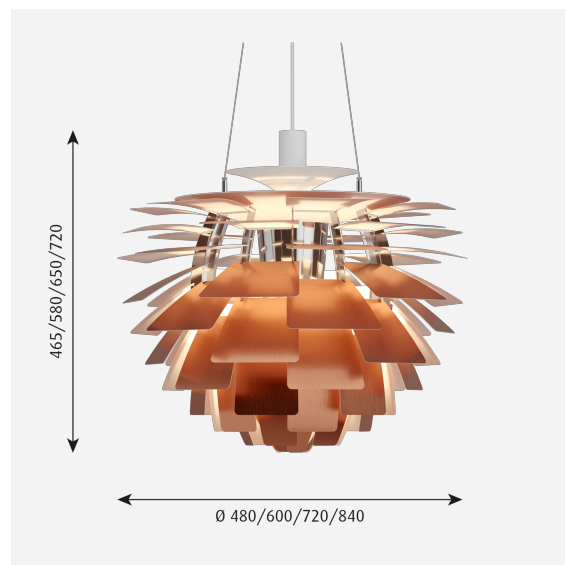

Related products

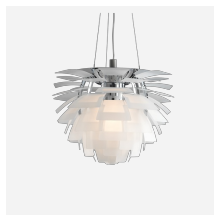

PH Artichoke Glass

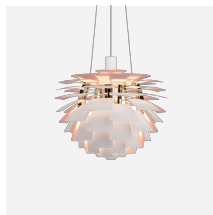

PH Artichoke Anniversary Edition

Product variants

Dimension	Colour	Light source	Lumen	Lighting control	Special accessories
Ø 480	● Black	1x100W E27	-	-	-
Ø 600	● Brass	LED 2700K 96W	1085	Dali	EXT. DRIVER
Ø 720	● Copper	LED 3000-1800K D2W 41W	1208	Phase dimming (mains dimm)	INT. DRIVER
Ø 840	● Stainless steel	LED 3000K 41W	1466	Wireless bluetooth	
			2037		
			2119		
			2387		
			2483		
			2505		
			2606		
			2621		
			2630		
			2726		
2736					
3030					
3152					
3538					
3631					
3681					
3777					
641					
779					
800					
894					
971					

Product description

Suspended spherical luminaire
 Shade consist of 72 overlapping leaves of laser cut glass or metal in a range of finishes
 Iconic design
 Family with four standard dimensions
 Two oversized versions for very large rooms available
 Chrome plated frame
 Top shade to hide insert
 Three wire suspension
 Canopy designed for lamp type

Mounting

Frame suspended from ceiling
 Lamp insert resting in top ring of frame
 Driver positioned internally in canopy (LED only)
 Option for driver positioned in driver box externally (LED Europe only)
 External driver box can be positioned up to 20m from luminaire (Europe only)
 Can be mounted on 4" octagonal junction box (US only)

Light description

100% glare free light
 The 100% reflected light creates a pattern of light and shadow on the underside of the leaves
 For glass The surface treatment on the glass leaves eliminates direct glare
 High play of light and shadow contrast in the luminaire
 Inside of leaves white on all metal versions of the luminaire
 Frosted glass leaves combines luminance with reflection
 Spherical light distribution
 LED replaceable
 Dimmable

Design

Poul Henningsen

Material

Laser cut metal leaves in either brushed copper, steel or painted high gloss white, 0.8 mm (0.03") thick.
 Sand blasted glass leaves, 4mm (0.16") thick.
 Suspended from three high quality stainless steel aircraft cables, 0.8mm (0.03") thick.
 High lustre chrome plated spun aluminium housing, 2mm (0.08") thick.
 Top shade: White, spun steel, 0.8 mm (0.03") thick.
 Frame: 12 legs of high lustre chrome plated, cast aluminum, 0.12" thick.
 LED enclosure: Custom-designed injection molded high-transmittance polycarbonate enclosure with internal reflector for proper illumination of leaves.
 LED thermally managed by system of 2 heatsinks, one cast aluminum and the other extruded aluminum.
 Upper heatsink with center open channel to maximum heat transferral to atmosphere.
 Three heat pipes efficiently transfer heat energy between heatsinks.
 Canopy (incandescent): 7.9" diameter x 3.6" tall cone of spun aluminum; canopy (LED): 9.4" diameter x 4.3" tall dome of white polycarbonate. (USA only)
 Cable: white PVC coated, 12 ft. Copper incandescent cable black PVC coated. (USA)
 Socket: Porcelain, medium base, for A-23, or mogul base for PS-35 clear envelope lamps.
 Socket position is adjustable to allow correct lamp position and fixture illumination.
 CMH variants provided with dual tap F-can style ballast to be remote located in ceiling plenum.
 LED variants available in 2700K (23.6") or 3000K (23.6", 28.3", 33.1") with CRI of 80.
 For LED variants, electronic constant current, class II driver for 120-277V operation and 0-10V dimming control housed inside canopy. (USA only)

Weight

Min: 13.881 kg Max: 9.569 kg

Dimensions

Ø 480, Ø 600, Ø 720, Ø 840

Finish

Black, Brass, Copper, Stainless steel, White

Light distribution diagrams

Cartesian

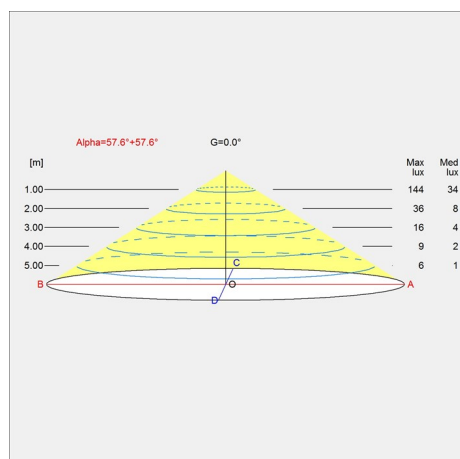

Isolux

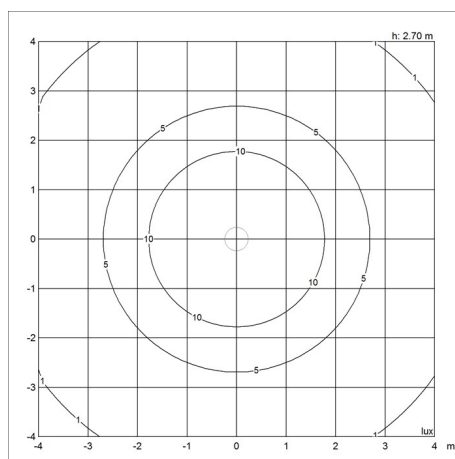

Polar

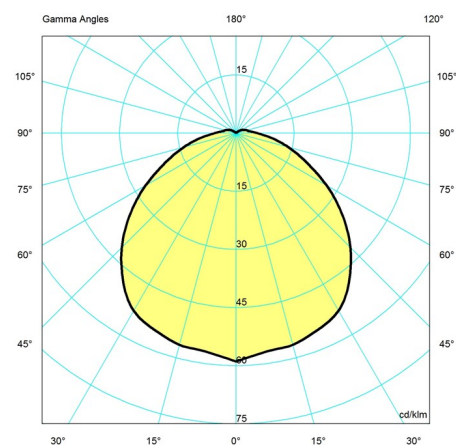

Spare parts & accessories

Product

PH Artichoke/Louvre/Lp centrum canopy

PH Artichoke Ø480, White canopy

Variant number

5741480272

5741086223