

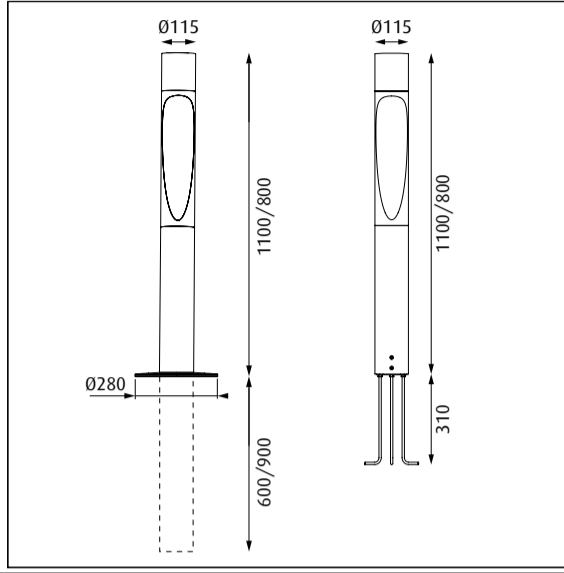

Design Christian Flindt



59041-11

Lyskilde Light source Leuchtmittel Ljuskälla Sorgenti luminose Source lumineuse Fuente de luz Valonlähde مصدر الضوء	Spænding/frekvens Voltage/frequency Spannung/frequenz Spänning/frekvens Tensione/frequenza Voltage/frequence Tensión/frecuencia Jännite/taajuus ترددية/فولطية	Vægt Weight Gewicht Vikt Peso/ingombro Poids Peso Paino وزن	Isolationsklasse Protection class Schutzklasse Isolationsklass Classe di isolamento Protection au choc électrique Clase de aislamiento Eristysluokka الحماية من الصدمات الكهربائية	Tæthedesklasse Ingress protection Schutzart Kapslingsklass Grado di protezione Indice de protection Clase de protección Kotelointiluokka الوقاية من التسرب	Vandalklasse Impact protection Stoßfestigkeit Vandalklass Protezione contro gli urti Protection aux chocs mécaniques Protección contra impactos Iskunkestävyys الحماية من الإرتطام
LED 	220-240V~, 50/60Hz	Max. 10,2 kg	Cl. I	IP 65	IK 10

**DA**  
Støv aftørres med en tør, blød klud. Fedtpletter og lignende kan fjernes med en blød klud opvredet i lunkent vand (<50° C) tilsat mildt rengøringsmiddel. Brug aldrig rengøringsmidler, der indeholder slibemiddel eller opløsningsmidler.

**EN**  
Wipe off dust with a dry, soft cloth. Remove greasy spots etc. with a soft cloth dampened in lukewarm water (<50° C) with a mild detergent. Never use detergents containing abrasives and solvents.

**DE**  
Staub bitte mit einem trockenen, weichen Lappen abwischen. Fettflecke und dgl. mit einem feuchten, in lauwarmem Wasser (<50° C) mit mildem Reinigungsmittel ausgewrungenen Lappen entfernen. Niemals Reinigungsmittel mit Schleifmittel oder Lösungsmittel verwenden.

**SV**  
Lampan dammtorkas med en torr, mjuk trasa. Fettfläckar tas bort med ljummet vatten (<50° C) utblandat med mildt rengöringsmedel. Använd aldrig rengöringsmedel som innehåller slipmedel eller lösningsmedel

**IT**  
Pulire la polvere esterna con un panno morbido e asciutto. Rimuovere macchie di grasso ecc. con un panno morbido inumidito in acqua tiepida (<50° C) e con un detergente leggero. Non usare mai detersivi contenenti abrasivi o solventi.

**FR**  
Essuyez la poussière avec un chiffon sec et doux. Enlevez les points de saleté etc. avec un chiffon doux imprégné d'eau claire tiède et de détergent doux. Ne jamais utiliser de détergents contenant des abrasifs et des solvants.

**ES**  
Limpiar con paño seco y suave. Quitar manchas de grasa y otras con paño suave humedecido con agua templada (<50° C) con detergente poco agresivo. Nunca use detergentes que contengan abrasivos y disolventes.

**FI**  
Pyyhi pölyt kuivalla pehmeällä liinalla. Poista rasvatahrat miedolla pesuaineella ja haalealla vedellä (<50° C) kostutetulla pehmeällä liinalla. Älä koskaan käytä liuottimia tai hankausaineita sisältäviä pesuaineita.

**AR**  
مسح الغبار بقطعة قماش ناعمة وناشفة. إزالة البقع الدهنية وغيرها باستخدام قطعة قماش ناعمة ومبللة بالماء الفاتر (أقل من 50 درجة مئوية) مع إضافة مسحوق تنظيف خفيف. يمنع استخدام المساحيق التي تحتوي على المواد الكاشطة أو المذيبات.

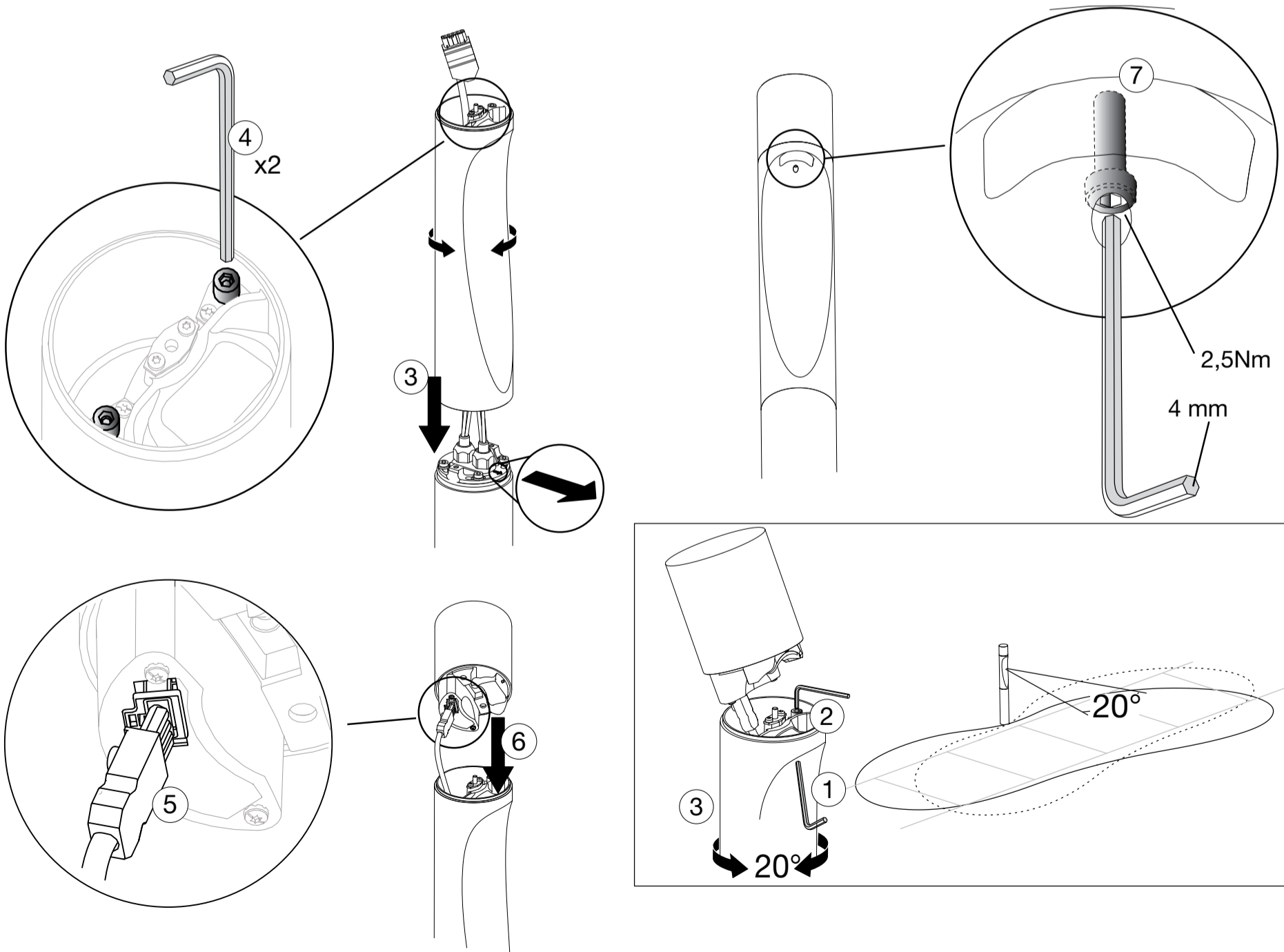
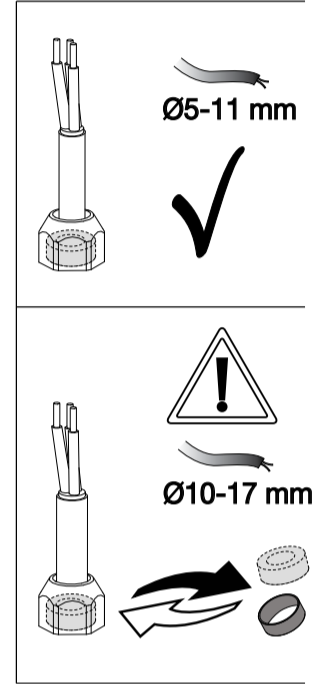
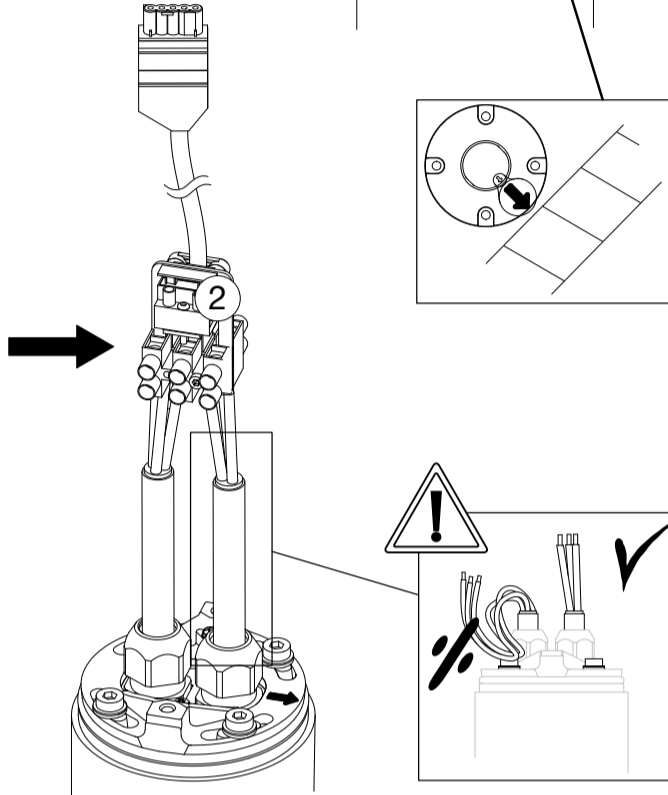
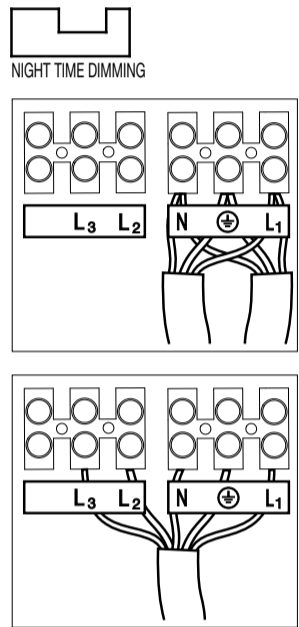
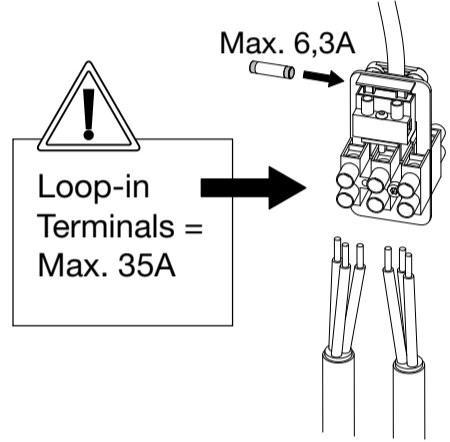
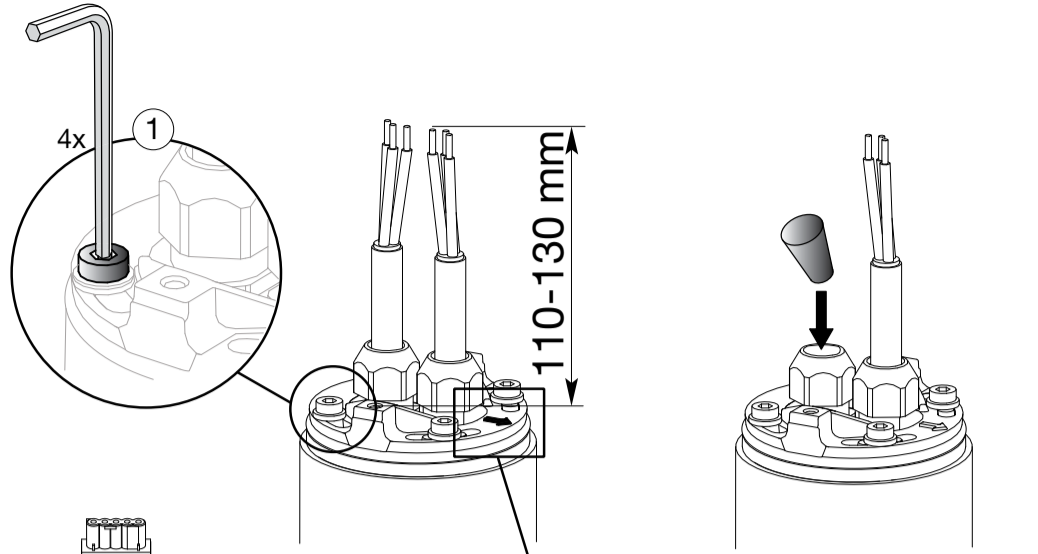
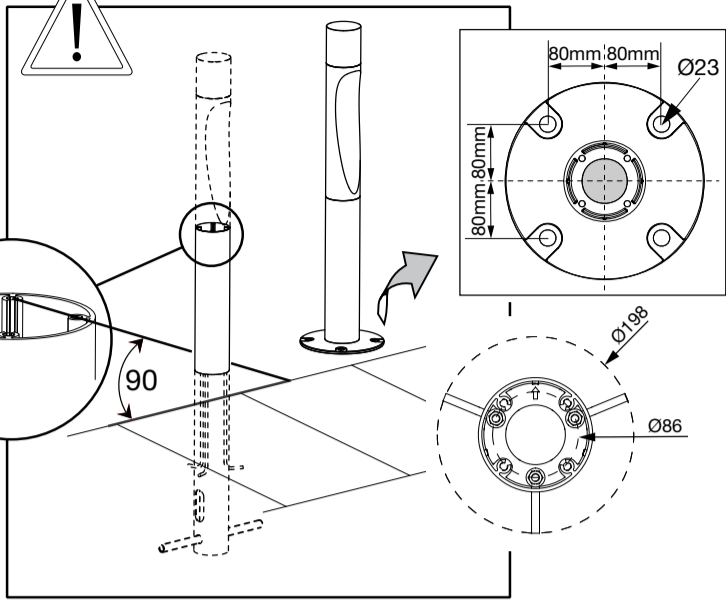
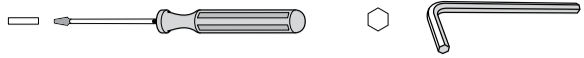



## Replaceability & Energy Efficiency Class

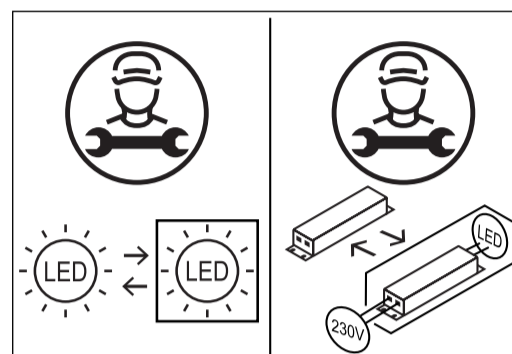

**DA**  
Dette produkt indeholder en lyskilde i energieffektivitetsklasse F.

**EN**  
This product contains a light source of energy efficiency class F.

**DE**  
Dieses Produkt enthält eine Lichtquelle der Energieeffizienzklasse F.

**SV**  
Denna produkt innehåller en ljuskälla med energieffektivitetsklass F.

**IT**  
Questo prodotto contiene una sorgente luminosa di classe di efficienza energetica F.

**FR**  
Ce produit contient une source lumineuse de classe d'efficacité énergétique F.

**ES**  
Este producto contiene una fuente luminosa de la clase de eficiencia energética F.

**FI**  
Tämä tuote sisältää valonlähteen, jonka energiatehokkuusluokka on F.

 **DA**  
Lyskilden i dette armatur må kun udskiftes af producenten eller en uddannet elektriker.

 **EN**  
The light source contained in this luminaire shall only be replaced by the manufacturer or a qualified electrician.

 **DE**  
Das in dieser Leuchte enthaltene Leuchtmittel sollte nur vom Hersteller oder von einem qualifizierten Elektriker ausgetauscht werden.

 **SV**  
Ljuskällan i denna armatur ska endast bytas ut av tillverkaren eller en kvalificerad elektriker.

 **IT**  
La sorgente contenuta in questa parte illuminante sarà solo riposizionata dal produttore o da un elettricista esperto.

 **FR**  
La source lumineuse de ce luminaire ne peut être remplacée que par le fabricant ou un électricien qualifié.

 **ES**  
La sustitución de la fuente de luz que contiene esta luminaria debe ser llevada a cabo exclusivamente por el fabricante o un electricista profesional.

 **FI**  
Tämän valaisimen valonlähteen saa vaihtaa ainoastaan valmistaja tai koulutettu sähköasentaja.

 **AR**  
يسمح فقط للمنتج أو لكهربائي مؤهل استبدال مصدر الضوء الموجود في وحدة الضوء هذه.