

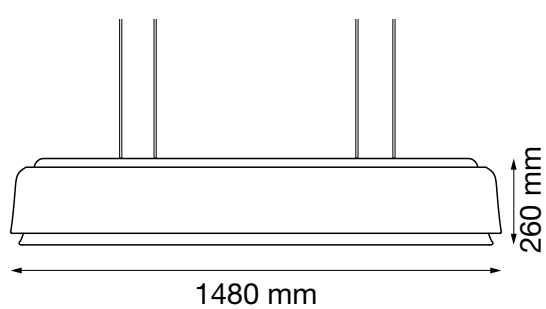

**louis poulsen**

# LP GRAND 1480 SUSPENDED

DESIGNED BY  
CHRISTIAN FLINDT



Lyskilde Light source Leuchtmittel Ljuskälla Sorgenti luminose Source lumineuse Fuente de luz Valonlähde	Spænding/frekvens Voltage/frequency Spannung/frequenz Spänning/frekvens Tensione/frequenza Voltage/frequence Tensión/frecuencia Jännite/taajuus	Vægt Weight Gewicht Vikt Peso/ingombro Poids Peso Paino	Isolationsklasse Protection class Schutzklasse Isolationsklass Classe di isolamento classe de protection clase de protección Eristysluokka	Tæthedsklasse Ingress protection Schutzart Kapslingsklass Grado di protezione Indice de protection Clase de protección Koteloituokka
LED 	230V 50Hz	45 kg	Cl. I	IP 20

**DA**

Støv aftørres med en tør, blød klud. Fedtpletter og lignende kan fjernes med en blød klud opvredet i lunkent vand (<50° C) tilsat mildt rengøringsmiddel. Brug aldrig rengøringsmidler, der indeholder slibemiddel, opløsningsmidler, alkohol eller syre.

**EN**

Wipe off dust with a dry, soft cloth. Remove greasy spots etc. with a soft cloth dampened in lukewarm water (<50° C) with a mild detergent. Never use detergents containing abrasives, solvents, alcohol or acid.

**DE**

Staub bitte mit einem trockenen, weichen Lappen abwischen. Fettflecke und dgl. mit einem feuchten, in lauwarmem Wasser (<50° C) mit mildem Reinigungsmittel ausgewrungenen Lappen entfernen. Verwenden Sie niemals Reinigungsmittel, die Schleifmittel, Lösungsmittel, Alkohol oder Säure enthalten.

**SV**

Lampan dammtorkas med en torr, mjuk trasa. Fettfläckar tas bort med ljummet vatten (<50° C) utblandat med mildt rengöringsmedel. Använd aldrig rengöringsmedel som innehåller slipmedel, lösningsmedel, alkohol eller syra.

**IT**

Pulire la polvere esterna con un panno morbido e asciutto. Rimuovere macchie di grasso ecc. con un panno morbido inumidito in acqua tiepida (<50° C) e con un detergente leggero. Non utilizzare mai detersivi contenenti abrasivi, solventi, alcool o acidi.

**FR**

Essuyez la poussière avec un chiffon sec et doux. Enlevez les points de saleté etc. avec un chiffon doux imprégné d'eau claire tiède et de détergent doux. N'employez jamais de détergents contenant des substances abrasives, des solvants, de l'alcool ou de l'acide.

**ES**

Limpiar con paño seco y suave. Quitar manchas de grasa y otras con paño suave humedecido con agua templada (<50° C) con detergente poco agresivo. No utilice nunca detergentes que contengan agentes abrasivos, disolventes, alcohol o ácido.

**FI**

Pyyhi pölyt kuivalla pehmeällä liinalla. Poista rasvatahrat miedolla pesuaineella ja haalealla vedellä (<50° C) kostutetulla pehmeällä liinalla. Älä koskaan käytä puhdistusaineita, jotka sisältävät hankaavia aineita, liuottimia, alkoholia tai happoa.

# Replaceability & Energy Efficiency Class



**DA**  
Dette produkt indeholder lyskilder i energieffektivitetsklasse D og E

**EN**  
This product contains light sources of energy efficiency class D and E

**DE**  
Dieses Produkt enthält Lichtquellen der Energieeffizienzklasse D und E

**SV**  
Denna produkt innehåller ljuskällor med energieffektivitetsklass D och E

**IT**  
Questo prodotto contiene fonti di luce nella classe di efficienza energetica D e E

**FR**  
Ce produit contient une source lumineuse de classe d'efficacité énergétique D et E

**ES**  
Este producto contiene fuentes de luz de la clase de eficiencia energética D y E

**FI**  
Tämä tuote sisältää valonlähteet, jonka energiatehokkuusluokka on D ja E

 **DA**  
Lyskilden i dette armatur må kun udskiftes af producenten eller en uddannet elektriker

 **EN**  
The light source contained in this luminaire must only be replaced by the manufacturer or a qualified electrician.

 **DE**  
Das in dieser Leuchte enthaltene Leuchtmittel sollte nur vom Hersteller oder von einem qualifizierten Elektriker ausgetauscht werden.



 **SV**  
Ljuskällan i denna armatur ska endast bytas ut av tillverkaren eller en kvalificerad elektriker.

 **IT**  
La sorgente contenuta in questa parte illuminante sarà solo riposizionata dal produttore o da un elettricista esperto.

 **FR**  
La source lumineuse de ce luminaire ne peut être remplacée que par le fabricant ou un électricien qualifié.

 **ES**  
Si el cable flexible externo de esta luminaria se dañara, debería ser reemplazado únicamente por el fabricante, o por su agente autorizado, o por una persona cualificada para así evitar peligros.

 **FI**  
Tämän valaisimen valonlähteen saa vaihtaa ainoastaan valmistaja tai koulutettu sähköasentaja.

Luminaire	CCT	E.E.C. ↓ 	E.E.C. ↑ 
LP Grand 1480	3000 K	12 x E	D

E.E.C. – Energy Efficiency Class

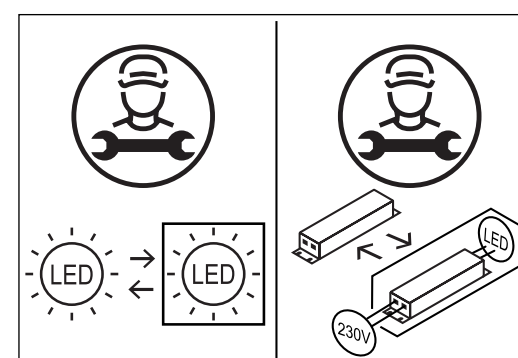

LOUIS POULSEN A/S  
KUGLEGAARDSVEJ 19-23,  
1434 COPENHAGEN K, DENMARK  
TEL. +45 70 33 14 14  
INFO@LOUISPOULSEN.DK  
WWW.LOUISPOULSEN.COM



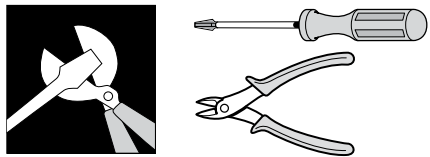

**DALI:**

**7a**

	L	N	⊕	DA DIM	DA
DA	Brun	Blå	Gul/Grøn	Grå	Sort
SV	Brun	Blå	Gul/Grøn	Grå	Svart
EN	Brown	Blue	Yellow/Green	Grey	Black
DE	Braün	Blau	Gelb/Grün	Grau	Schwarz
IT	Marrone	Blu	Giallo/Verde	Grigio	Nero
FR	Brun	Bleu	Jaune/Vert	Gris	Noir
ES	Marrón	Azul	Amarillo/Verde	Gris	Noir
FI	Ruskea	Sininen	Keltainen/Vihreä	Harmaa	Musta

**1-10V:**

**7b**

	L	N	⊕	+ DIM	-
DA	Brun	Blå	Gul/Grøn	Grå	Sort
SV	Brun	Blå	Gul/Grøn	Grå	Svart
EN	Brown	Blue	Yellow/Green	Grey	Black
DE	Braün	Blau	Gelb/Grün	Grau	Schwarz
IT	Marrone	Blu	Giallo/Verde	Grigio	Nero
FR	Brun	Bleu	Jaune/Vert	Gris	Noir
ES	Marrón	Azul	Amarillo/Verde	Gris	Noir
FI	Ruskea	Sininen	Keltainen/Vihreä	Harmaa	Musta

SWITCH-CONTROL

